



SUNHEATER

SWIMMING POOL SOLAR HEATING SYSTEMS

for Aboveground Pools

Product Number S220

INSTALLATION & OPERATION MANUAL

How Solar Pool Heating Works

- Using your pool pump, water is automatically pumped through the solar collectors.
- As sun shines on the collector, the water is then heated as it moves through it.
- The heated water is returned back to the pool, through your return lines.
- You enjoy your own heated pool with no fuel costs.

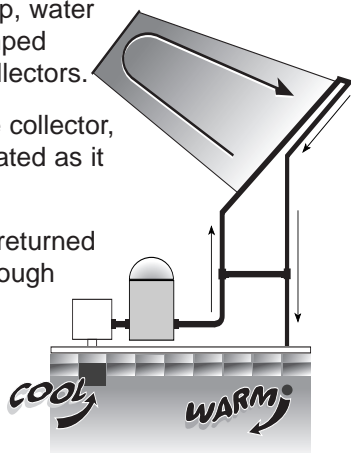

Why Solar Heat Works Best

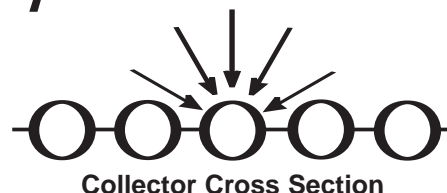

- Water is heated as it moves through the many tubes in the solar collectors.
- Tube and web design traps heat and catches light as the sun moves across the sky.
- Tough polypropylene material won't rust, corrode or scale. Plus, the collector is reversible.

PLEASE READ THIS MANUAL CAREFULLY. YOUR ENJOYMENT OF YOUR SOLAR HEATED POOL AND YOUR WARRANTY ARE AFFECTED BY HOW YOUR SOLAR HEATING SYSTEM IS INSTALLED

CAUTION: a) Solar collectors are often installed on the roofs of buildings. Unless you are very familiar with working on roofs and have the proper ladders and safety equipment for such work, you should hire someone with the necessary experience to do the installation. Failure to observe safe practices on a roof or other elevated structure may result in falling, leading to serious injury to you.

b) When installing collectors on the ground, do not build a rack support that could allow children access into the pool.

IMPORTANT READ THIS ENTIRE MANUAL BEFORE STARTING ORIENTATION

How Well Does Solar Heating Work?

A properly sized and installed system will raise pool temperatures up to 10°F during the season. You will only want to circulate water through the solar collector when the sun is shining. When it's cloudy or rainy, solar won't work as well (and you probably won't be swimming during those times), but your water will be back up to temperature after one or two warm days.

Do I Need A Special Pump?

If your pool pump is in good working condition, there shouldn't be any problem using your existing pump. A one HP pump will handle installations up to 30 feet away from the pool equipment and one story up. If the collectors are cool to touch when the water is running through them on a warm sunny day, you are getting enough flow.

Where Can I Put The Solar Collectors?

Anywhere you get at least 6 hours of full sun during the day. The longer the collectors are in full sun, the better they will work. If you are mounting the solar on an angle (like a roof or rack), the collectors should face in a southerly direction. For roof or rack mounting, you'll need 1 SK-43 mounting kit (one SK43 will secure up to two S220 collectors). For high wind areas, we recommend one SK-34 High Wind Kit for each collector. Call SmartPool at 1-888-560-7665 for ordering info.

What Tools Will I Need?

- Flat head screwdriver or 5/16" nut driver

For roof or rack mounting you will also need:

- Power drill
- 1/8" drill bit and a Phillips head bit
- Silicone sealant (GEII or equivalent)

What additional parts will I need to install the solar system on a roof?

- 1 SmartPool Mounting Kit SK-43 (will secure up to two S220 collectors). High wind SK-34 for each collector in high wind areas.
- You will need the correct amount of 1 1/2" Schedule 40 PVC pipe for the plumbing, going to and from your pool equipment.
- You will also need PVC primer, glue, and fittings (available where you buy PVC pipe).

What additional parts will I need to install the solar system on the ground or on a rack?

- For a ground mount installation you will require 2 hoses - one that will reach from the pool equipment to the collector and one that reaches from the collector back to the pool.
- For a rack mount installation you'll need SmartPool's mounting kit SK-43. For high wind areas you will need one SK-34 for each collector.

USE OF NON-FACTORY MOUNTING HARDWARE WILL VOID YOUR WARRANTY!

**WARNING! POSITION THE RACK SO THAT IT DOES NOT
PROVIDE ACCESS TO THE POOL FOR CHILDREN.**

How much will the solar system weigh when filled with water?

Each solar box will weigh approximately 40 lbs. when filled with water. There is very little additional load on your roof since the weight is dispersed over a large area.

Pool Sizes		Number of Solar Boxes	Area Needed
Round	Oval		
12' - 18'	12' x 24'	1	3 ft x 21 ft
21' - 24'	15' x 30' - 16' x 25'	2	5 ft x 21 ft
27' - 28'	16' x 32' - 18' x 34'	3	7 ft x 21 ft

Use a solar blanket to hold in heat at night or during cool weather.

Product # S220 Kit Components

Kit	Qty	Item #	Description
	1	SCPNL220	2' x 20' Polypropylene Solar Collectors
	1	SC018HSE	18" inch Plastic Flex Hose

SK-32		System Kit for S220	
	2	69003	Elbow Connectors
	2	69002	PVC End Caps 1 1/2" FPT
	2	SC125CLMP	1 1/4" Stainless Steel Hose Clamps 35-51
	1	60554	Teflon Tape 1/2"
	1		Installation Manual w/Warranty Statement

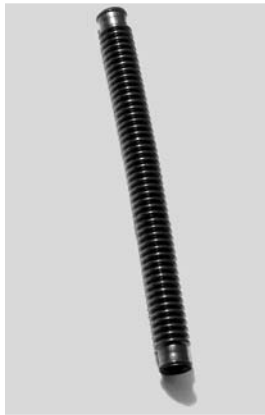

SC018HSE



SK-32

SunHeater collectors are manufactured with special molds and materials designed to provide you with the most durable, high performance solar pool heating system available. Note: during manufacturing certain mechanical incisions are required to complete the assembly of the collector (see photos on right). These are normal and do not adversely affect the performance or durability of your SunHeater.

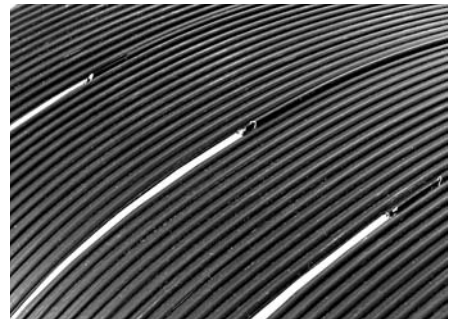

Please Note: Small holes in collector (see photo at right) are NOT to be used for mounting. Use only SmartPool-approved mounting kit SK43 and follow the directions provided. Failure to comply will void your warranty.

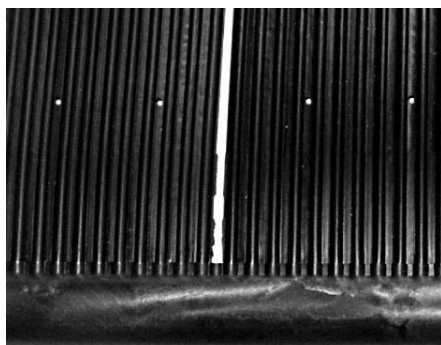

SYSTEM LAYOUT

Single System

Required:

- Flathead screwdriver or 5/16" nut driver.
- To install your solar heating system you will require 2 hoses - one that will reach from the pool equipment to the collector and one that reaches from the collector back to the pool.

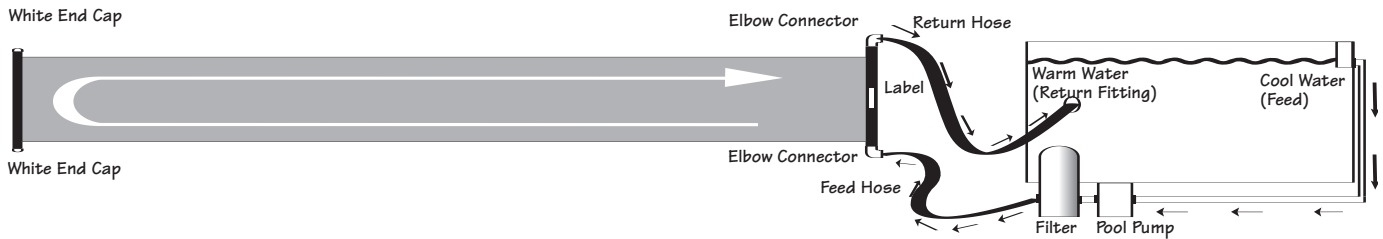

1. Provide an area that is free of any sharp objects with at least 6 hours of full sunlight a day.
2. Remove strap from collector and unroll it placing the headers with the serial number label closest to your pool equipment.
3. Allow the collector to relax in the sun (30 minutes to an hour). **DO NOT LAY COLLECTOR ON THE GRASS IT CAN DAMAGE THE LAWN UNDERNEATH! DO NOT WALK ON COLLECTOR.**
4. Remove and discard the black protective end caps covering the threaded ends of the header pipes.
5. Wrap the threaded ends of the headers with Teflon tape provided (as shown) for a watertight seal.
6. On the header without the label, thread white end caps on the open ends (as shown). Be careful not to cross-thread.
7. Thread elbow connectors on the open ends of the header with the label (as shown). Be careful not to cross-thread.
8. Turn off pool pump.
9. Go to pool and plug the round return fitting on the pool wall from the inside, so the water won't drain through (a winter plug works well).
10. Connect a hose from the filter to the lower elbow connector. Always fill the system from the bottom.
11. Connect another hose from pool return fitting to other elbow connector.
12. From the inside of the pool wall, remove the plug you placed in the round return fitting.

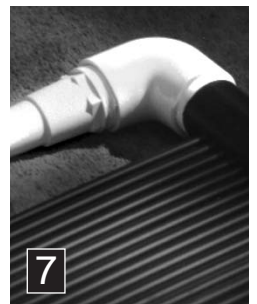

YOU ARE NOW READY TO START-UP YOUR SOLAR POOL HEATER

13. Turn on the pump. Check for leaks and tighten the connections that need attention.

Note: Upon start-up you will see air bubbles come through the return hose. This is normal and will stop after all the air has been purged from the solar heating system.

CONNECTIONS FOR TWO COLLECTORS

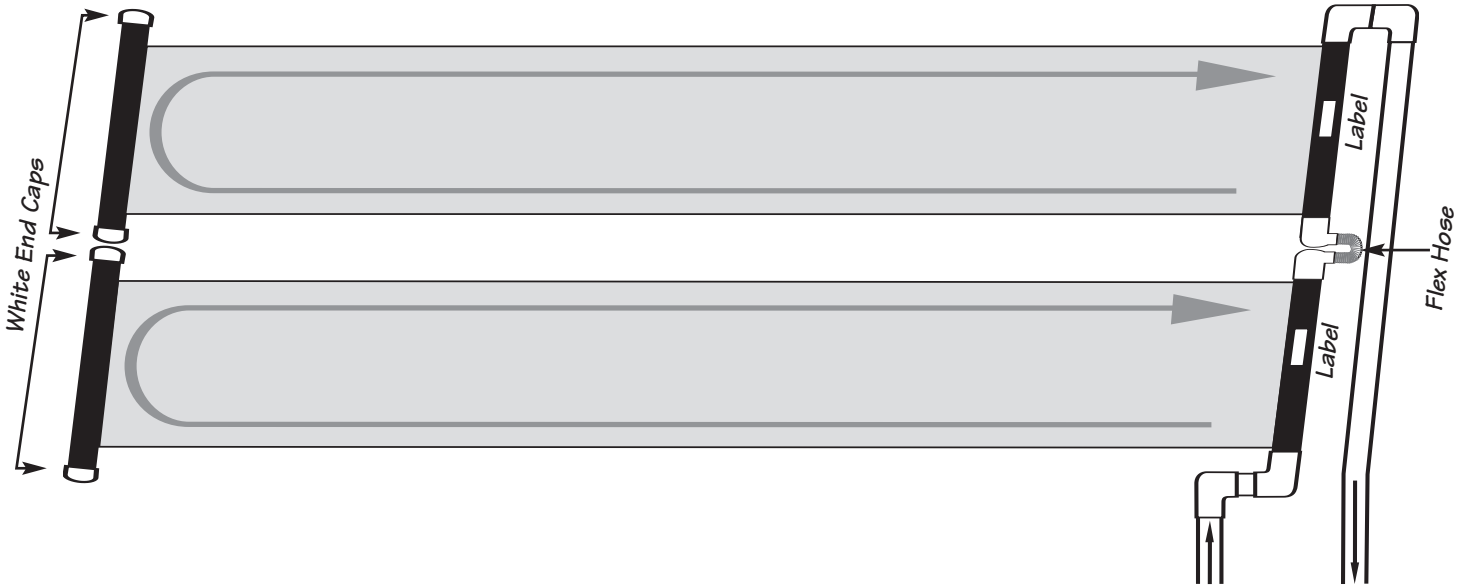

CONNECTIONS FOR THREE COLLECTORS

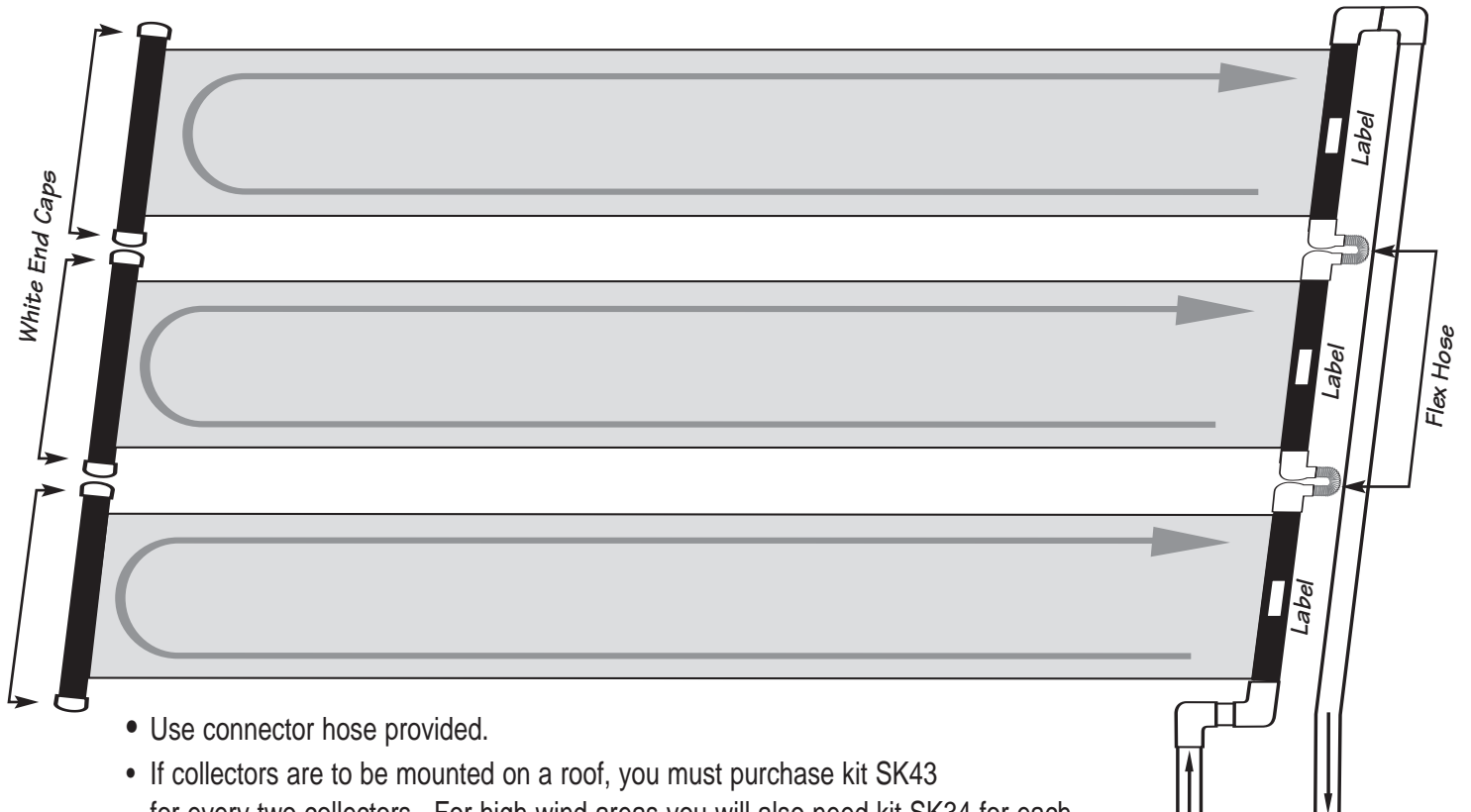

- Use connector hose provided.
- If collectors are to be mounted on a roof, you must purchase kit SK43 for every two collectors. For high wind areas you will also need kit SK34 for each collector. Call your dealer or SmartPool at 888-560-7665.
- Slots are provided in each solar collector for mounting (DO NOT USE SMALL HOLES IN COLLECTORS FOR MOUNTING - SEE PAGE 3. DOING SO WILL VOID YOUR WARRANTY).
- Maximum of three collectors may be plumbed in series.
- Pitch the collectors slightly toward the end caps for winterizing and draining (1"-2").
- Do not add additional mounting hardware other than SmartPool factory approved kits.

OPERATION & MAINTENANCE

Operation

1. The collector should feel cool to the touch when the sun is shining on the collector and water is passing through. This means that the heat is being transferred to the water.
2. The water returning to your pool will be a few degrees (3-5 degrees) warmer than the pool itself. This is the most efficient way to heat a large body of water like a pool. Keep circulating the water and add a few degrees each pass.
3. Circulate water through the solar collector at least 6 hours per day during the daylight hours on sunny days. If you circulate your water through the collector at night, or when it's overcast or on chilly days, you will cool your pool water rather than heat it. If you need to run your pump at night, open the diverter valve so that water goes directly back to the pool, bypassing the solar system.

Winterization

YOUR SOLAR SYSTEM MUST BE DRAINED FOR WINTERIZATION! FREEZE DAMAGE IS NOT COVERED UNDER WARRANTY! YOU MUST DRAIN YOUR SOLAR COLLECTORS JUST LIKE YOU DRAIN THE REST OF YOUR POOL EQUIPMENT!

Remove the white end cap at the top of the solar system. Remove the white end cap at the bottom and be sure ALL the water is drained out of the system. Replace end caps and blow pressurized air through the system. After blowing them out, remove and store the bottom end cap for use again in the spring when you start up again. You can leave the collectors in place (as long as they are completely drained) and they will withstand even the harshest winters. Of course, you can store your collectors inside in a warm dry place if you like.

Collector Repair

IF THE COLLECTOR DEVELOPS A LEAK

Your solar collector is warranted against defects in materials and workmanship. If a leak develops for any other reason, you may use the repair method shown. The collector is not warranted against freeze damage.

SOLAR COLLECTOR REPAIR

This method allows for an easy and permanent, on-site repair of a collector by isolating the leading riser tube. Referring to the figure at the right, locate the tube to be isolated. (End tube has been shown for clarity). Using a sharp utility knife, very carefully cut away approximately 1" of the tube at both headers. Drive a #10 sheet metal screw, preferably stainless, into the hole in the header. The screw must be between 1/2" and 3/4" long.

DO NOT OVERTIGHTEN! If the screw strips out, or if the repair leaks, use a #12 screw. This repair method will not void the collector warranty.

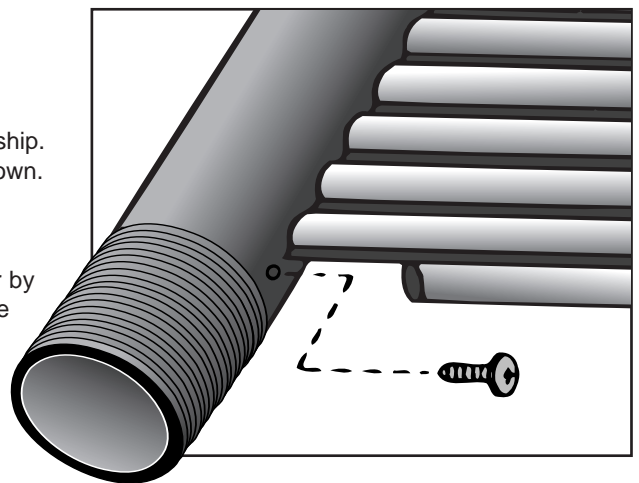

With proper care and winterization, you will enjoy your solar collectors for many years.